

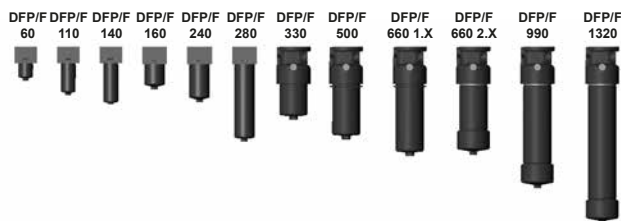

Pressure Filter for Manifold Mounting DFP and for Reversible Flow DFPF up to 620 l/min, up to 315 bar



1. TECHNICAL SPECIFICATIONS

1.1 FILTER HOUSING

Construction

The filter housings are designed in accordance with international regulations. They consist of a filter head and a screw-in filter bowl. DFPF filters are suitable for flow in both directions.

Standard equipment:

- connection for a clogging indicator
- two-piece bowl for DFP/F 990 and above (optional for DFP/F 660 and above)
- drain screw with pressure relief (standard for DFP/F 330 and above)

1.2 FILTER ELEMENTS

HYDAC filter elements are validated and their quality is constantly monitored according to the following standards:

- ISO 2941
- ISO 2942
- ISO 2943
- ISO 3724
- ISO 3968
- ISO 11170
- ISO 16889

Contamination retention capacities in g

DFP/F	Betamicron® (BN4HC)			
	3 µm	5 µm	10 µm	20 µm
60	6.5	7.3	7.8	8.0
110	13.8	15.5	16.4	16.9
140	18.1	20.3	21.5	22.2
160	19.8	22.2	23.5	24.3
240	32.3	36.3	38.4	39.6
280	70.6	79.3	83.9	86.6
330	47.2	53.1	56.1	57.9
500	76.9	86.5	91.5	94.4
660	102.2	114.9	121.5	125.4
990	154.5	173.7	183.7	189.5
1320	209.9	236.0	249.6	257.5

DFP/F	Betamicron® (BH4HC)			
	3 µm	5 µm	10 µm	20 µm
60	4.6	4.5	5.0	5.7
110	10.1	9.9	10.9	12.4
140	13.3	13.0	14.3	16.3
160	12.9	12.6	13.9	15.9
240	21.6	21.1	23.2	26.5
280	48.1	47.1	51.8	59.1
330	34.6	33.9	37.2	42.5
500	57.5	56.3	61.8	70.5
660	76.8	75.2	82.6	94.3
990	111.8	109.4	120.2	137.2
1320	153.8	150.7	165.5	188.8

1.3 FILTER SPECIFICATIONS

Nominal pressure	315 bar * (see below)
Fatigue strength	At nominal pressure 10 ⁶ cycles (LC) from 0 to nominal pressure
Temperature range	-30 °C to +100 °C (-30 °C to -10 °C: p _{max} = 157.5 bar)
Material of filter head	EN-GJS 400-15
Material of filter bowl	Steel
Type of clogging indicator	VD (differential pressure measurement up to 420 bar operating pressure)
Pressure setting of the clogging indicator	5 bar for DFP (others on request) 8 bar for DFPF (others on request)
Bypass cracking pressure (optional)	6 bar (others on request)

Filter elements are available with the following pressure stability values:

Betamicron® (BN4HC):	20 bar
Betamicron® (BH4HC):	210 bar
Wire mesh (W):	20 bar
Stainless steel fibre (V):	210 bar

1.4 SEALS

NBR (=Perbunan)

1.5 INSTALLATION

Pressure filter for manifold block mounting, with or without reversible oil flow

1.6 SPECIAL MODELS AND ACCESSORIES

- bypass valve built into the head
- Seals in FPM, EPDM

1.7 SPARE PARTS

See Original Spare Parts List

1.8 CERTIFICATES AND APPROVALS on request

1.9 COMPATIBILITY WITH HYDRAULIC FLUIDS ISO 2943

- Hydraulic oils H to HLPD DIN 51524
- Lubrication oils DIN 51517, API, ACEA, DIN 51515, ISO 6743
- Compressor oils DIN 51506
- Biodegradable operating fluids VDMA 24568 HETG, HEES, HEPG
- Fire-resistant fluids HFA, HFB, HFC and HFD
- Operating fluids with high water content (> 50 % water content) on request

1.10 IMPORTANT INFORMATION

- Filter housings must be earthed.
- When using visual clogging indicators, the BM version (visual with manual reset) only should be used.
- When using electrical clogging indicators, the electrical power supply to the system must be switched off before removing the clogging indicator connector.

Symbol for hydraulic systems

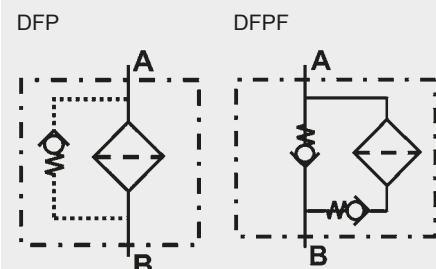

*

	Size 330 - 660	
	with bypass	without bypass
0-315 bar	95,000 LC	400,000 LC
0-350 bar	80,000 LC	350,000 LC

LC = load cycles

2. MODEL CODE (also order example)

DFP BN/HC 60 Q B 10 D 1 . X /-L24

2.1 COMPLETE FILTER

Filter type _____

DFP or DFPF

Filter material _____

BN/HC Betamicron® (BN4HC)

BH/HC Betamicron® (BH4HC)

V Metal fibre

W Wire mesh

Size of filter or element _____

DFP/F: 60, 110, 140, 160, 240, 280, 330, 500, 660, 990, 1320

Operating pressure _____

Q = 315 bar

Type and size of connection _____

Type	Connection type	Filter size										
		60	110	140	160	240	280	330	500	660	990	1320
B	Ø 17.5	●	●	●								
C	Ø 21.4				●	●	●					
D	Ø 41							●	●	●	●	●

Filtration rating in µm _____

BN/HC, BH/HC, V: 3, 5, 10, 20

W: 25, 50, 100, 200

Type of clogging indicator _____

Y plastic blanking plug in indicator port

A steel blanking plug in indicator port

BM visual

C electrical

D visual and electrical

for other clogging indicators, see brochure no. 7.050../..

Type code _____

1 one-piece filter bowl

2 two-piece filter bowl (DFP/F 660 to 1320)

Modification number _____

X the latest version is always supplied

Supplementary details _____

B. bypass cracking pressure (e.g. B6 = 6 bar); without details = without bypass valve

L... light with appropriate voltage (24, 48, 110, 220 Volt)

LED 2 light-emitting diodes up to 24 Volt

SO184 pressure release/oil drain screw (standard for size DFP/F 330 and above)

V FPM seals

W suitable for HFA and HFC emulsions

2.2 REPLACEMENT ELEMENT

0060 D 010 BN4HC /-V

Size _____

0060, 0110, 0140, 0160, 0240, 0280, 0330, 0500, 0660, 0990, 1320

Type _____

D

Filtration rating in µm _____

BN4HC, BH4HC, V: 003, 005, 010, 020

W: 025, 050, 100, 200

Filter material _____

BN4HC, BH4HC, V, W

Supplementary details _____

V, W (for descriptions, see point 2.1)

2.3 REPLACEMENT CLOGGING INDICATOR

VD 5 D . X /-L24

Type _____

VD differential pressure indicator up to 420 bar operating pressure

Pressure setting _____

5 standard for DFP filters 5 bar

8 standard for DFPF filters 8 bar

others on request

Type of clogging indicator _____

D (see Point 2.1)

Modification number _____

X the latest version is always supplied

Supplementary details _____

L..., LED, V, W (for descriptions, see Point 2.1)

3. FILTER CALCULATION / SIZING

The total pressure drop of a filter at a certain flow rate Q is the sum of the housing Δp and the element Δp and is calculated as follows:

$$\Delta p_{\text{total}} = \Delta p_{\text{housing}} + \Delta p_{\text{element}}$$

$$\Delta p_{\text{housing}} = (\text{see Point 3.1})$$

$$\Delta p_{\text{element}} = Q \cdot \frac{SK^*}{1000} \cdot \frac{\text{viscosity}}{30}$$

(*see Point 3.2)

For ease of calculation, our Filter Sizing Program is available on request free of charge.

NEW: Sizing online at www.hydac.com

3.1 Δp -Q HOUSING CURVES BASED ON ISO 3968

The housing curves apply to mineral oil with a density of 0.86 kg/dm³ and a kinematic viscosity of 30 mm²/s. In this case, the differential pressure changes proportionally to the density.

DFP 60/110/140

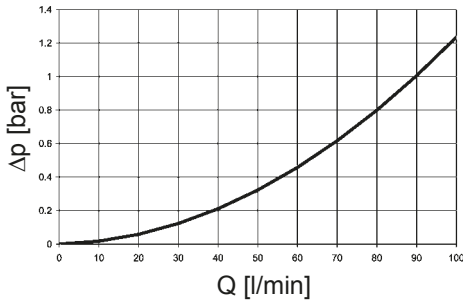

DFP 160/240/280

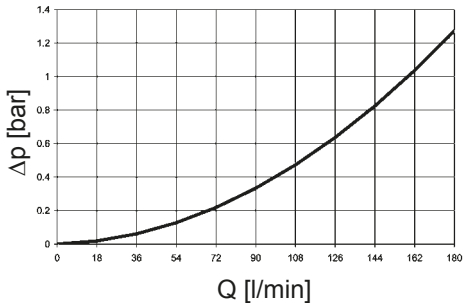

DFP 330/500/660/990/1320

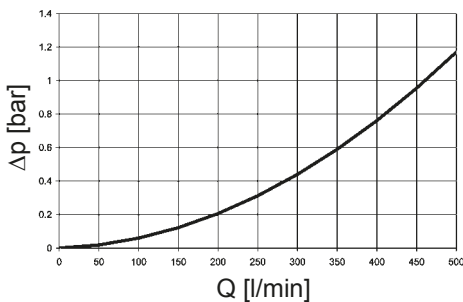

DFPF Δp -Q housing curves on request

3.2 GRADIENT COEFFICIENTS (SK) FOR FILTER ELEMENTS

The gradient coefficients in mbar/(l/min) apply to mineral oils with a kinematic viscosity of 30 mm²/s. The pressure drop changes proportionally to the change in viscosity.

DFP/ DFPF	V				W	BH4HC			
	3 μm	5 μm	10 μm	20 μm		-	3 μm	5 μm	10 μm
60	16.0	11.0	6.5	3.3	0.757	58.6	32.6	18.1	12.2
110	8.3	6.0	4.2	2.1	0.413	25.4	14.9	8.9	5.6
140	5.9	3.8	3.0	1.7	0.324	19.9	11.3	8.1	4.3
160	4.5	3.2	2.3	1.4	0.284	16.8	10.4	5.9	4.4
240	3.2	2.4	1.9	1.1	0.189	10.6	6.8	3.9	2.9
280	1.5	1.2	1.0	0.8	0.162	5.7	3.4	1.8	1.6
330	2.1	1.5	1.3	0.8	0.138	7.7	4.5	2.8	2.0
500	1.4	1.0	0.8	0.5	0.091	4.2	2.6	1.5	1.2
660	1.1	0.9	0.6	0.3	0.069	3.3	1.9	1.0	0.9
990	0.7	0.5	0.4	0.3	0.046	2.2	1.3	0.8	0.6
1320	0.6	0.5	0.3	0.2	0.035	1.6	1.0	0.6	0.4

BN4HC: 60

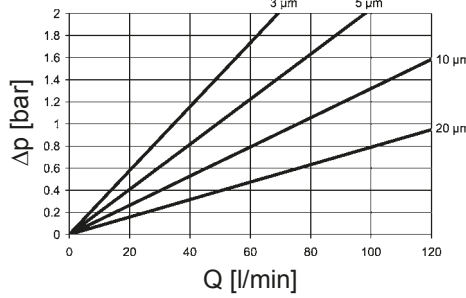

BN4HC: 110

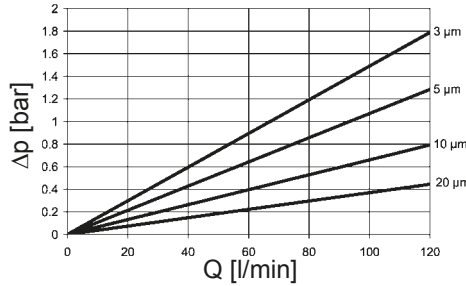

BN4HC: 140

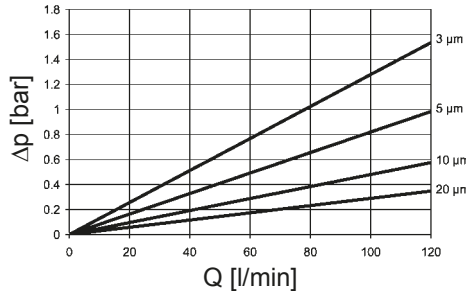

BN4HC: 160

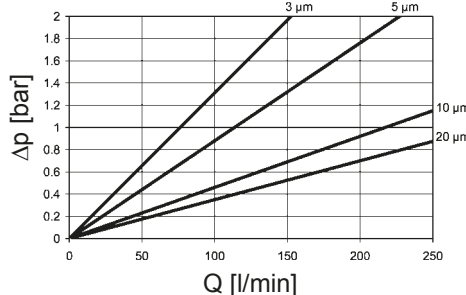

BN4HC: 240

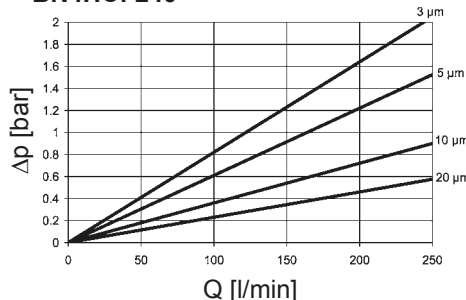

BN4HC: 280

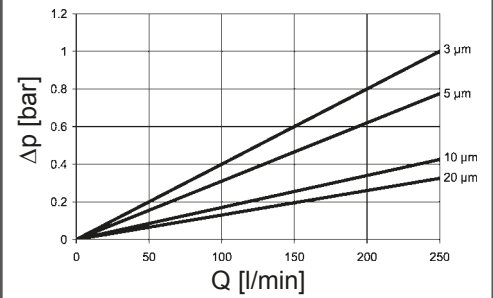

BN4HC: 330

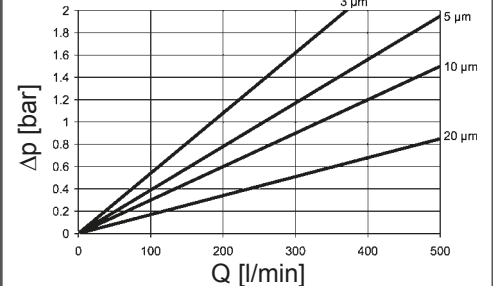

BN4HC: 500

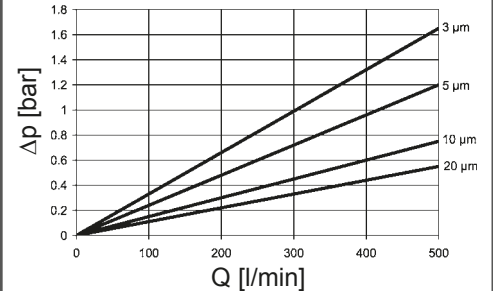

BN4HC: 660

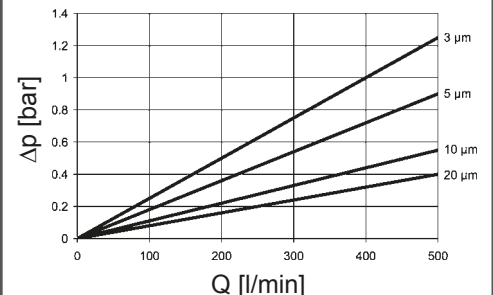

BN4HC: 990/1320

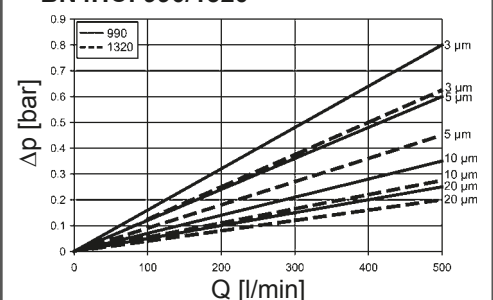

4. DIMENSIONS: DFP

DFP 60 - 280

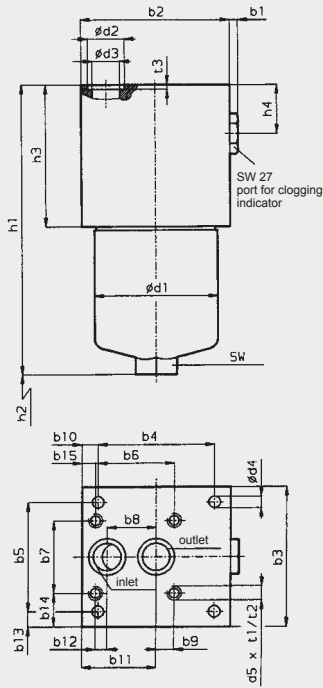

DFP 330 - 1320

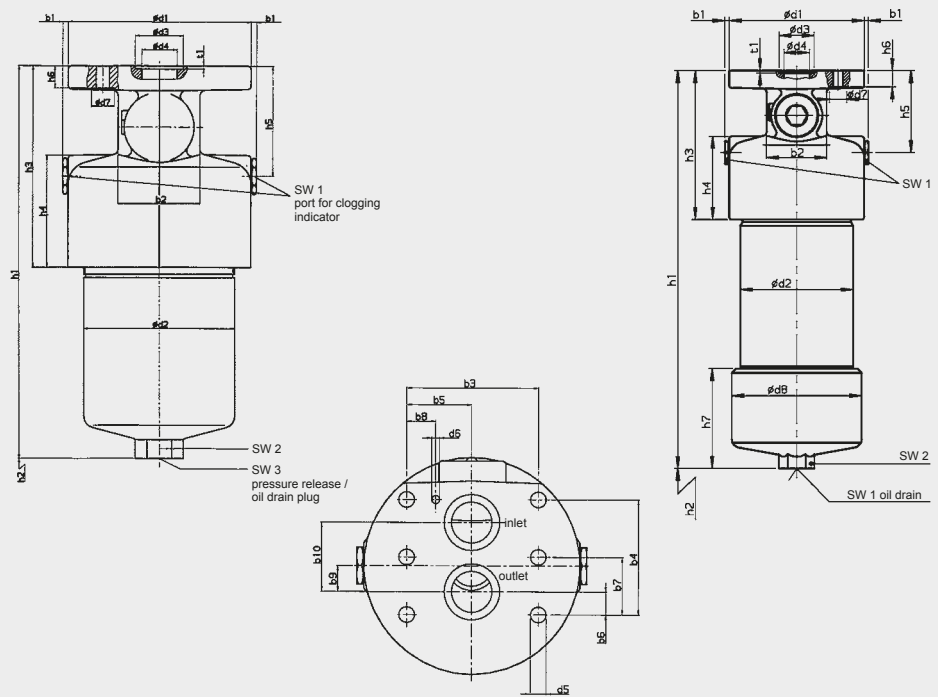

DFP	60	110	140	160	240	280	330	500	660	990	1320
b1	6	6	6	6	6	6	5	5	5	5	5
b2	104	104	104	115	115	115	70	70	70	70	70
b3	80	80	80	110	110	110	96.8	96.8	96.8	96.8	96.8
b4	89	89	89	90	90	90	84.1	84.1	84.1	84.1	84.1
b5	31.8	31.8	31.8	86	86	86	48.4	48.4	48.4	48.4	48.4
b6	-	-	-	61	61	61	16.7	16.7	16.7	16.7	16.7
b7	-	-	-	57	57	57	42.05	42.05	42.05	42.05	42.05
b8	31.6	31.6	31.6	38	38	38	21.4	21.4	21.4	21.4	21.4
b9	-	-	-	14	14	14	19	19	19	19	19
b10	7.5	7.5	7.5	12.5	12.5	12.5	50.7	50.7	50.7	50.7	50.7
b11	55.9	55.9	55.9	57.5	57.5	57.5	-	-	-	-	-
b12	-	-	-	9	9	9	-	-	-	-	-
b13	24.1	24.1	24.1	12	12	12	-	-	-	-	-
b14	-	-	-	26.5	26.5	26.5	-	-	-	-	-
b15	-	-	-	10.5	10.5	10.5	-	-	-	-	-
d1	68.2	68.2	68.2	95.2	95.2	95.2	158	158	158	158	158
d2	25.3	25.3	25.3	28.6	28.6	28.6	130	130	130	130	130
d3	17.5	17.5	17.5	21.4	21.4	21.4	41	41	41	41	41
d4	8.5	8.5	8.5	9	9	9	30	30	30	30	30
d5	-	-	-	7/16-14 UNC	7/16-14 UNC	7/16-14 UNC	11.5	11.5	11.5	11.5	11.5
d6	-	-	-	-	-	-	6	6	6	6	6
d7	-	-	-	-	-	-	20	20	20	20	20
d8	-	-	-	-	-	-	-	-	-	152	152
h1	158.5	227.5	269.5	199.5	263.5	445.0	339.5	432.5	510.0	660.0	826.0
h2	75	75	75	85	85	85	95	95	95	500	670
h3	76	76	76	83	83	83	174.5	174.5	174.5	174.5	174.5
h4	25	25	25	25	25	25	98	98	98	98	98
h5	-	-	-	-	-	-	96	96	96	96	96
h6	-	-	-	-	-	-	19	19	19	19	19
h7	-	-	-	-	-	-	-	-	-	112	112
t1	-	-	-	13	13	13	2.6	2.6	2.6	2.6	2.6
t2	-	-	-	18	18	18	-	-	-	-	-
t3	2	2	2	2	2	2	-	-	-	-	-
SW	27	27	27	32	32	32	-	-	-	-	-
SW1	-	-	-	-	-	-	27	27	27	27	27
SW2	-	-	-	-	-	-	36	36	36	36	36
SW 3	-	-	-	-	-	-	10	10	10	10	10
Weight incl. element [kg]	5.1	6.0	6.6	9.1	10.4	14.7	21.0	25.5	29.0	39.2	47.1
Volume of pressure chamber [l]	0.20	0.33	0.40	0.60	0.80	1.60	1.50	2.30	3.00	4.20	5.60

DFFP

DFFP 60 - 280

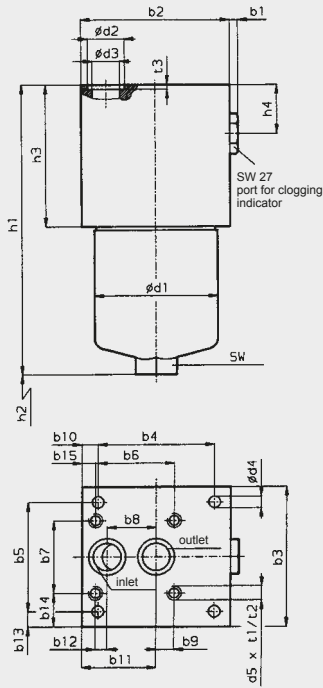

DFFP 330 - 1320

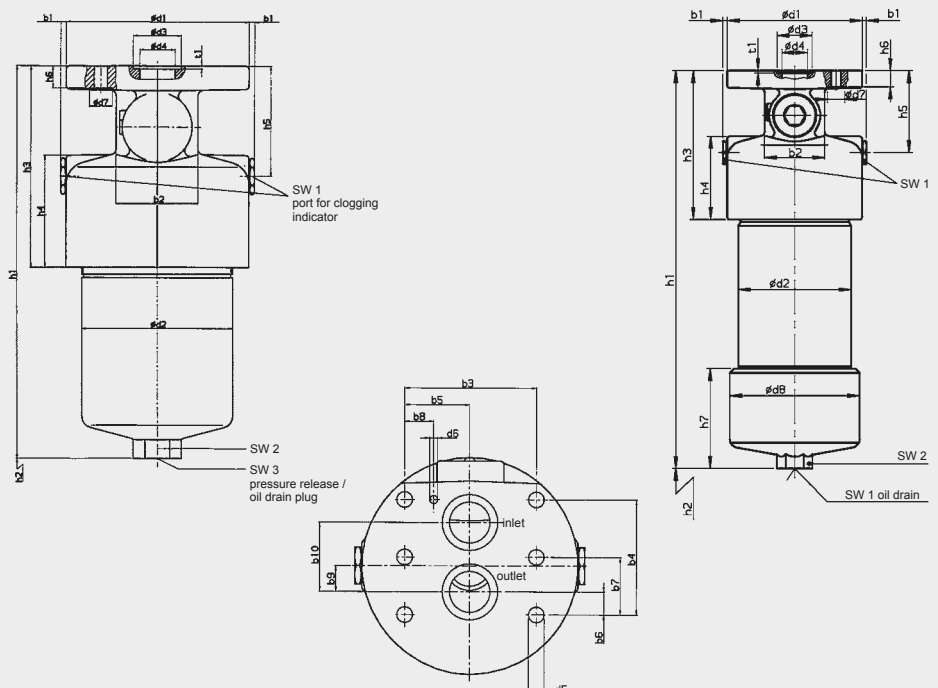

DFFP	60	110	140	160	240	280	330	500	660	990	1320
b1	6	6	6	6	6	6	5	5	5	5	5
b2	104	104	104	120	120	120	70	70	70	70	70
b3	80	80	80	110	110	110	96.8	96.8	96.8	96.8	96.8
b4	89	89	89	90	90	90	84.1	84.1	84.1	84.1	84.1
b5	31.8	31.8	31.8	86	86	86	48.4	48.4	48.4	48.4	48.4
b6	-	-	-	61	61	61	16.7	16.7	16.7	16.7	16.7
b7	-	-	-	57	57	57	42.05	42.05	42.05	42.05	42.05
b8	31.6	31.6	31.6	38	38	38	21.4	21.4	21.4	21.4	21.4
b9	-	-	-	14	14	14	19	19	19	19	19
b10	7.5	7.5	7.5	17.5	17.5	17.5	50.7	50.7	50.7	50.7	50.7
b11	55.9	55.9	55.9	62.5	62.5	62.5	-	-	-	-	-
b12	-	-	-	9	9	9	-	-	-	-	-
b13	24.1	24.1	24.1	12	12	12	-	-	-	-	-
b14	-	-	-	26.5	26.5	26.5	-	-	-	-	-
b15	-	-	-	15.5	15.5	15.5	-	-	-	-	-
d1	68.2	68.2	68,295,2	95.2	95.2	158	158	158	158	158	158
d2	25.3	25.3	25.3	28.6	28.6	28.6	130	130	130	130	130
d3	17.5	17.5	17.5	21.4	21.4	21.4	41	41	41	41	41
d4	8.5	8.5	8.5	9	9	9	30	30	30	30	30
d5	-	-	-	7/8-14 UNC	7/8-14 UNC	7/8-14 UNC	11.5	11.5	11.5	11.5	11.5
d6	-	-	-	-	-	-	6	6	6	6	6
d7	-	-	-	-	-	-	20	20	20	20	20
d8	-	-	-	-	-	-	-	-	-	152	152
h1	158.5	227.5	269.5	206.5	266.5	448.5	339.5	432.5	510.0	660.0	826.0
h2	75	75	75	85	85	85	95	95	95	95	95
h3	76	76	76	90	90	90	174.5	174.5	174.5	174.5	174.5
h4	21	21	21	32	32	32	98	98	98	98	98
h5	-	-	-	-	-	-	96	96	96	96	96
h6	-	-	-	-	-	-	19	19	19	19	19
h7	-	-	-	-	-	-	-	-	-	112	112
t1	-	-	-	13	13	13	2.6	2.6	2.6	2.6	2.6
t2	-	-	-	18	18	18	-	-	-	-	-
t3	2	2	2	2	23	2	-	-	-	-	-
SW	27	27	27	32	32	32	-	-	-	-	-
SW1	-	-	-	-	-	-	27	27	27	27	27
SW2	-	-	-	-	-	-	36	36	36	36	36
SW 3	-	-	-	-	-	-	10	10	10	10	10
Weight incl. element [kg]	5.1	6.0	6.6	9.1	10.4	14.7	21.0	25.5	29.0	39.2	47.1
Volume of pressure chamber [l]	0.20	0.33	0.40	0.60	0.80	1.60	1.50	2.30	3.00	4.20	5.60

